



*An Online CPD Course
brought to you by
CEDengineering.ca*

An Introduction to Gas Insulated Electrical Substations

Course No: E03-043
Credit: 3 PDH

Donald Parnell, P.E.



Continuing Education and Development, Inc.

P: (877) 322-5800
info@cedengineering.ca

An Overview of Gas-Insulated Substations

Course Summary:

This course provides an brief introductory overview of (GIS) or Gas Insulated Substations.

A gas insulated substation (GIS) is a high voltage substation in which the major conducting structures are contained within a sealed environment with a dielectric gas known as SF₆, or sulfur hexafluoride gas as the insulating medium.

In comparison, a conventional (AIS) or Air-Insulated Substation, uses atmospheric air as the dielectric gas medium, as these types of substations primarily consist of outdoor facilities.

Topics covered in this course:

- Overview of a GIS System
- Hybrid GIS Substations
- Advantages and Disadvantages of GIS Systems
- SF6 gas, leak detection, and gas monitoring systems
- Physical arrangements used in GIS
- International Standards on GIS
- Economics of GIS vs AIS
- Contaminants and Oxidation in the Gas
- Enclosure Modules for a GIS System
- Conductors in a GIS System
- Circuit Breakers and Transformers used in GIS Systems
- Switching and Arrester Devices used in GIS Systems
- Connections in a GIS Systems
- The Control System of a GIS
- Testing and Installation
- Operational Procedures for a GIS

Overview of a GIS System



What is a Gas Insulated Substation?

A gas insulated substation (GIS) is a high voltage substation in which the major conducting structures are contained within a sealed environment with a dielectric gas known as SF₆, or sulfur hexafluoride gas as the insulating medium.

In comparison, a conventional (AIS) or Air-Insulated Substation, atmospheric air is the dielectric gas medium, as these types of substations are almost always located at outdoor locations.

Origin of GIS technology

GIS technology originally began in Japan in the 60's, where there was a critical need to develop substations with a greatly reduced footprint.

GIS was slowly adopted by various other countries over the following years. After about 5 years of evaluation and testing, GIS system construction increased to about 20% of new substations in countries with severe space limitations.

For countries with space readily available, the higher cost of GIS relative to AIS has limited its adoption to special needs cases. In the US, only about 2 to 5% of new substations are constructed as GIS.

Clearances for GIS, roughly a tenth of that for AIS

With GIS technology, the clearance needed for phase to phase or phase to ground for all equipment is much less than that of an AIS or air insulated substation .

The total space required for a GIS is roughly a tenth of that needed for a conventional AIS facility. While the conventional, AIS requires several feet of air insulation to isolate a conductor, SF6 gas insulation only needs inches, allowing a GIS facility to fit into areas far smaller than that of a AIS facility. A GIS is mainly constructed where real estate space is expensive or scarce.



Environmentally Protected System

GIS technology is a good choice to use in arctic or desert locations, as it can be enclosed in a building which is environmentally protected from extreme conditions.

In addition to protecting the system components from extreme heat and cold, GIS technology encloses the electrical components within a Faraday cage which shields the system from potential lightning strikes.



Gas Tight Modular Design

Each compartment housing the live sections of the GIS system is gas tight, with respect to one another. This ensures that the gas is not allowed to pass to an adjacent module, as well as ensures that gas monitoring is independent.

'O' rings - are installed at the equipment and enclosure flanges to insure the gas tight integrity of the modules.

Gas monitoring system - this includes an integrated alarm system, as well as automated tripping and lockout features in case of low pressure conditions due to leakage. This is critical, as when the pressure of the dielectric gases drop, so does the insulating capability of the SF6 gas.



High Voltage Installations

Gas insulated technology becomes more desirable as the voltage requirements increase. As an example, the footprint of a 765kV conventional substation is considerably large. A station footprint of this sized station would be significantly less were it to employ GIS.

Urban Installations

GIS technology can be used for installations in areas where the cost of real estate or the aesthetic appeal and safety is a significant consideration.

When acquiring land for a conventional AIS station in some densely populated areas, it can be cost prohibitive, politically sensitive (when eminent domain is required to seize the land), or downright impossible to locate. Imagine attempting to build a high voltage AIS in urban areas such as downtown New York city.



Expansion of Existing AIS - Mixed Technology Switchgear

One approach to the expansion of existing AIS, is mixed technology switchgear (or hybrid GIS.) This approach is especially suitable for the expansion of an existing substation, without requiring large areas of additional real estate, which is often unavailable.

This design uses GIS breakers, switches, and voltage/current transformers with interconnections between the breaker positions and connections to other equipment using air-insulated conductors .



Indoor Installations

The construction of an indoor air insulated substation would be highly impractical and difficult to operate safely. However, a gas insulated substation can easily go inside an industrial building.

It can be incorporated into the electrical infrastructure of an industrial facility, allowing for onsite stepping down of voltage.

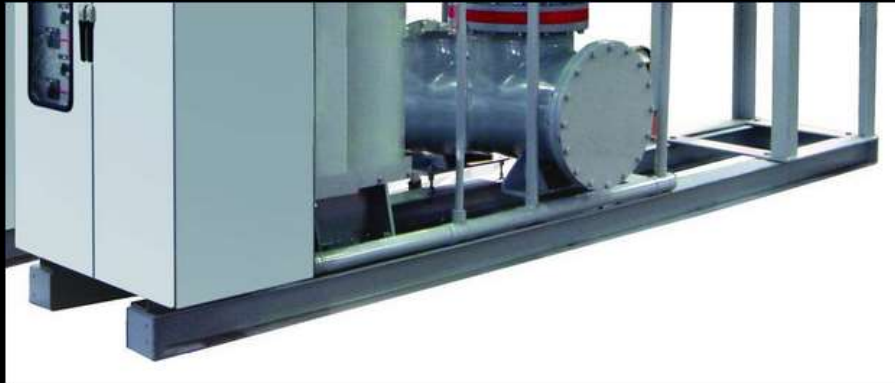

The GIS System's Foundation

GIS systems are usually installed on a monolithic concrete pad or directly on the floor of a housing facility. The system is attached by bolting or welding the GIS support frames to embedded steel plates of beams, or by the use of chemical drill anchors.

Expansion Joints

Expansion drill anchors - These are not recommended, as the dynamic loading from circuit breaker operations may loosen the expansion anchors over time.

Bus expansion joints – This type of expansion joint may be recommended in the large GIS installations. The expansion joints are installed between the various sections of the GIS to adjust to the “fitup” in the field. They can also be installed to address thermal expansion of the GIS system.

Disadvantages of GIS Systems

- System cost is higher compared to that of a conventional AIS.
- Delivery of SF6 gas to the site can be problematic.
- GIS substations are indoor type, requiring a separate building.
- System cleaning / maintenance are critical to reduce conductive particle contamination.
- Particle or moisture contamination inside the compartment causes flash overs.
- Outages can be extremely long, and the damage to the system will normally be severe following a fault condition at a GIS substation.
- Access to live parts for maintenance is more problematic, and harder to diagnose without gas reclamation and disassembly of the modules.

Disadvantages of the Conventional AIS System

- Equipment deteriorates when exposed to ambient atmospheric conditions.
- Equipment becomes contaminated when exposed to pollutants such as airborne particulate matter.
- Requires a lot of real estate, which can be expensive to acquire in dense urban areas; may require the use of eminent domain to secure the necessary parcels.
- Less stable, with reduced safety of operation compared to GIS, in seismic regions.
- Requires regular maintenance.
- Requires special consideration in regions with altitudes higher than 3000 ft. mean sea level, due to the lesser density of the dielectric gas (atmospheric air).
- The poor dielectric properties of air, as well as secondary factors such as humidity, pollutants, salt, and moisture means that more space is needed.

SF6 Gas

A gas-insulated substation (GIS) uses a superior dielectric gas, sulfur hexafluoride (SF6), at a moderate pressure for phase to phase and phase to ground insulation.

The high-voltage conductors, circuit breaker interrupters, switches, current transformers, and voltage transformers are totally encapsulated within the grounded metal enclosures surrounded by pressurized SF6 gas.



GIS Protects Components from Exposure to the Elements

In a GIS, the active components of the system are protected from deterioration due to exposure to atmospheric air, moisture, particulate contamination, etc.

This results in a system which is more reliable, requires less maintenance, and will have a longer service life (in excess of 40 years) than its conventional AIS counterpart.

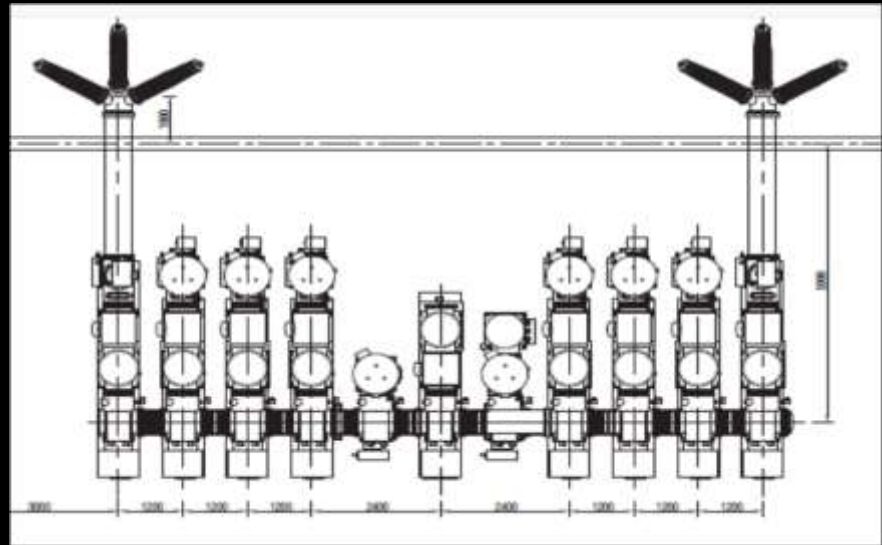

Popular Physical Arrangement for the GIS

For any one-line diagram there can be several possible physical arrangements. When deciding upon the physical arrangement, the shape of the site for the GIS and the nature of connecting lines and cables should be considerations.

Double Busbar Configuration - Most GIS designs were initially developed for a double bus, single break arrangement. This popular approach has good reliability, and is simple to operate. Additionally, it allows for easy protective relaying, excellent economy, and provides a small footprint.

International Standards on GIS

International standards for GIS are covered under CIGRE publications.

What is CIGRE?

From the CIGRE website:

“Founded in 1921, CIGRE, the Council on Large Electric Systems, is an international non-profit Association for promoting collaboration with experts from all around the world by sharing knowledge and joining forces to improve electric power systems of today and tomorrow.”

The IEEE and the IEC also have standards and technical specifications which cover the design, testing, installation and use of GIS systems.



IEC Standards

Additional international standards for GIS are covered under IEC code.

The International Electro-technical Commission or IEC, is an international standards organization that prepares and publishes international standards for all electrical, electronic and related technologies.

IEC standards cover a variety of technologies from power generation, transmission and distribution to home appliances and office equipment, semiconductors, fiber optics, batteries, solar energy, nanotechnology and marine energy as well as many others.

IEC GIS Standard: 62271-203 - High-voltage switchgear and control gear –Part 203: Gas-insulated metal-enclosed switchgear for rated voltages above 52 kV

The Economics of GIS vs AIS

GIS vs AIS Costs

Equipment Costs - GIS equipment is probably always going to be higher than that of AIS due to the grounded metal enclosure, the provision of an LCC, and the high degree of factory assembly.

Installation Costs - GIS is less expensive to install than an AIS, as it is mostly assembled at the factory.

Site Development Costs - GIS will always be much lower than for an AIS, because of the much smaller footprint needed. The cost advantages realized by site development of GIS increases as the system voltage increases. This is because high-voltage AIS needs a lot of room for the long insulating distances of atmospheric air.

Cost comparisons

Early cost comparisons of GIS projected that, on the basis of a total installed cost,

The cost of a GIS would equal the cost of an AIS when the voltage of the substation reached the 345 kV range. As voltages went above the 345kV threshold, GIS facilities would be the cheaper alternative over AIS.

Present-day cost analysis have shown though, that the cost of AIS has been reduced substantially by advances in technology and manufacturing processes, while GIS equipment has shown no similar reductions in cost.

Perception of GIS being too Costly to Implement

Even though GIS has been a well-established substation technology for a long time, with a proven track record of high reliability, requiring a minimal amount of maintenance, it is still perceived as being too costly and only applicable to special needs cases where space is the primary deciding factor.

Going Digital will help Reduce Assembly Size

Currently, the cost of GIS costs is being reduced by integrating certain functions performed among the components of the system. For example, as digital control systems become the norm in substations replacing analog, pricey electromagnetic CTs and VTs of a GIS will eventually be replaced by less expensive sensors such as the optical VTs and the Rogowski coil CTs.

These sensors are much smaller, thus reducing the size of the GIS assemblies, allowing more bays of GIS equipment to be shipped turnkey, and fully assembled. This allows for lower Installation and site development costs, thus the advantages of GIS compared to AIS increase.

SF6 – a Superior Dielectric Gas

What is (SF6) or Sulfur Hexafluoride Gas?

Sulfur hexafluoride is a nontoxic, inert and nonflammable gas consisting of a sulfur atom surrounded by and tightly bonded to six fluorine atoms.

Sulphur hexafluoride (SF6) is the most common insulation gas in high voltage technology because of the electron attachment (electron affinity.)

SF6 is around five times the density of atmospheric air at mean sea level, and has no color, odor, or taste. SF6 is almost purely water insoluble, and as with all other gases, its solubility decreases as the temperature of the water increases.

SF6 Gas Pressure

SF6 gas is enclosed in GIS systems at pressures between 400 to 600 kPa absolute. This pressure range is ideal, to prevent the gas from condensing into a liquid at the lowest potential temperatures which the equipment may be subjected to.

SF6 is a gas in which the speed of sound propagation is about three times less than in air, (at atmospheric pressure.) The sound of the interruption of the arc will thus be quieter in SF6 than in air.



Dielectric Strength: SF6 Gas vs Air

SF6 has a three times higher dielectric strength at 0.1 Mpa (1 atm or atmospheric conditions) compared to air. When the pressure within the GIS enclosure increases, so does the dielectric strength of the SF6 gas, due to the increase in density.

At pressures such as those within a GIS enclosure, the dielectric strength of the SF6 gas can become much higher than that of atmospheric air.

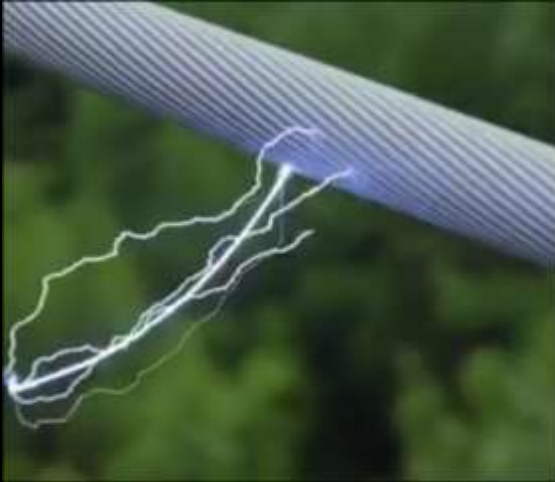

Arc-Interrupting Ability of SF6 Gas

SF6 tends to be roughly 100 times more effective for interrupting arcs than air.

SF6 has become the standard for interrupting mediums, used in high-voltage circuit breakers applications, replacing older insulating mediums, composed of oil and air.

Reactive Decomposition Byproducts

There are however, some reactive decomposition byproducts which are formed due to the interaction between the sulfur and fluorine ions with the trace quantities of moisture, air, and other contaminants found in the system environment.

These quantities formed are typically miniscule, and molecular sieve absorbents (see image) within the GIS enclosure will aid in eliminating these reactive byproducts over time.



Toxic Breakdown Gases from SF6

HF - Hydrofluoric (HF) acid, is a toxic breakdown product of SF6. It is typically a gas, with a boiling point of approximately 19°C. Symptoms of exposure are delayed. Due to its high reactivity, it does not have a long half-life.

SO2 - Sulphur dioxide (SO2), a toxic breakdown product of SF6. It is typically a gas (boiling point approximately -10°C).

SOF2 - Thionyl fluoride (SOF2), a toxic breakdown product of SF6. It decomposes over time in the presence of moisture into SO2 and HF. It is a colorless gas with a pungent odor (similar to rotten eggs), condensing at approximately -43°C.



Gas Storage

SF₆ gas is usually delivered in 50 kg gas cylinders in a liquid state, at a pressure of roughly 6000 kPA.

Gas Handling Systems

Gas handling systems include components such as filters, compressors, and vacuum pumps which are commercially available.

The best practices and personnel safety considerations for SF₆ gas handling are addressed in international standards.





SF6 as a Greenhouse Gas

SF6 is a strong greenhouse gas that has the potential to seriously contribute to the effects of global warming. At an international treaty conference in Kyoto, Japan in 1997, SF6 was listed as one of the six greenhouse gases whose emissions should be reduced.

Half-life of SF6 – Even though SF6 is a relatively minor contributor to the total amount of greenhouse gases, it has a very long life in the atmosphere, with a half-life which is estimated at 3,200 years.

So the effect of even small quantities of SF6 being released into the atmosphere is cumulative and permanent, unlike some other greenhouse pollutants, which are quicker to dissipate.



Gas Recycling

To control gas leakage from a GIS system, the SF₆ is completely contained within the sealed enclosures, allowing for full reclamation and recycling.

By following the present international guidelines for use of SF₆ in electrical equipment, the contribution of SF₆ to global warming can be kept to less than 0.1% over a 100-year period, when guidelines are stringently followed by GIS personnel.



Gas Emissions Reduction Measures

The rates of SF₆ gas emissions from use of high voltage electrical equipment have been reduced over time. This is mainly due to utilities adopting better handling and recycling practices.

Field checks of GIS in service for many years have shown that the leak rate objective can be as low as 0.1% per year if handling and recycling standards were to be revised.

Contaminants and Oxidation in the Gas



Condensation as Moisture

The SF6 gas in the enclosures must be dry enough to prevent condensation of moisture onto the surfaces of the epoxy support insulators, as moisture on the surface can cause a dielectric breakdown.

Use of absorbents - inside the enclosures will help to reduce the moisture levels in the gas, though over time moisture evolves from the internal surfaces and out of the solid dielectric materials.



Gas Dew Points; Condensation as Ice

Condensation as Ice - when the moisture condenses as ice, the breakdown voltage is not affected.

Gas Dew Points – Thus gas dew points should be maintained below approximately -10°C . Additionally, levels below 1000 ppmv of moisture are typically specified, and easily obtainable when careful gas handling is practiced.



Small Conducting Particles

Small conducting mm-sized particles will significantly reduce the dielectric strength of a SF6 gas. This negative effect on the system will increase as the pressure is raised above 600 kPa absolute.

Dielectric Breakdown - These conducting particles are transported by the electrical field in the gas. Dielectric breakdown can occur when the particles move to the higher field regions inside the equipment or are deposited along the surface of the solid epoxy support insulators.

Maintaining a clean environment in the GIS assembly is therefore critical for proper operation.

Removing Particles from the Enclosure

Detection - During the factory and field power frequency high voltage tests, contaminating particles can be detected as they are transported by the electric field, causing small electric discharges and acoustic signals.

Removal - Once detected, they can be removed by opening the equipment. Some GIS equipment is outfitted with internal “particle traps” that capture these particles before they relocate where they might cause breakdown.

Most GIS assemblies are appropriately shaped to provide low electric field regions, where particles can come to rest without causing breakdowns.

Contaminants in Used SF6 Gas

Reactive liquids such as oil, and solid contaminants in used SF6 are easily removed by filters, though inert gaseous contaminants such as oxygen and nitrogen are not easily removed.

Oxygen and nitrogen - are introduced during normal gas handling processes, or by accident, such as when all the air from the equipment is not properly evacuated prior to filling with the enclosure with the SF6.

Required Gas Purity - fortunately, the purity of the SF6 needs to only be above 98% as established by international standards , so a simple field test of gas purity using commercially available percentage SF6 meters will qualify the used SF6 for reuse.



Recycling SF6

When severe situations of gas contamination occur, the SF6 manufacturers will take back the contaminated SF6, and reprocess it, in effect turning it back into a new SF6 product.

Permanently retiring the gas - though not yet a common situation, an end of life scenario for the eventual retiring of SF6 gas product, is the incineration of the SF6 along with materials that will enable it to become part of environmentally acceptable gypsum.



Emissions Reduction Programs

The US EPA agency has a voluntary SF6 emissions reduction program for the electric utility industry that keeps track of emissions rates.

This program provides information on techniques for reducing emissions, and rewards utilities that have effective SF6 emission reduction programs in place.

Other local agencies have addressed the concern in a similar manner or have even considered outright banning, or simply taxing the use of SF6 in electrical equipment.

Safer Alternatives to SF6

There are alternative types of gas (to SF6) that exist for medium voltage electric power equipment. However, there are no viable alternatives which have been identified for use in high-voltage electric power equipment, in spite of years of painstaking research.

The alternatives have shown a number of disadvantages that outweigh any advantage they may have in respect to a lower greenhouse gas effect.

Thus, SF6 will continue to be used for GIS where interruption of power system faults and switching is concerned.



SF6 with Nitrogen for GIL

One alternative gas which is being used for longer bus runs without any arcing such as in (GIL) or gas-insulated transmission lines, is introducing a mixture of SF6 with nitrogen for reducing the total amount of SF6 in the enclosure.

Enclosure Modules for a GIS System

Types of Equipment Modules

GIS systems are assembled from standard equipment modules.

Types of modules include:

- circuit breakers
- current transformers
- voltage transformers
- disconnect and ground switches
- interconnecting bus
- surge arresters
- connections to the rest of the electric power system



Single Phase and Three Phase Enclosures

Systems up to around 170 kV - all three phases are often combined into one enclosure.
Systems above 170 kV - the size of the three-phase enclosure becomes too large to be practical. So a “single-phase enclosure” design is used instead.

No established performance differences exist between the three-phase enclosure and the single-phase enclosure GIS, with some manufacturers using single-phase enclosures for all levels of voltage.



Joining and Sealing Enclosure Modules

GIS enclosure modules are joined together using bolted flanges which have an “O”-ring sealing system for the enclosure.

The conductors have a sliding plug-in contact for connecting the conductor sections.



Internal Support Insulators within Modules

Parts on the interior of the GIS are supported with cast epoxy insulators, which allow for a gas barrier between parts of the GIS, or are cast with holes in the epoxy to allow gas to pass through from one side to the other.

These support insulators are made of an epoxy resin, which is carefully cast to avoid the formation of voids or cracks during the curing process.

The epoxy material is formulated and the insulator is shaped, for optimizing electric-field distribution, mechanical strength, resistance to surface electric discharge, and for convenience in manufacturing and assembly.



Epoxy Support Insulators

Cast epoxy support Insulators come in types such as post, disk, and cone.

Integrity testing - when testing the integrity of support insulators, a high-voltage power frequency withstand test with sensitive partial discharge monitoring is used. The electric-field stress inside the cast epoxy insulator should be below a certain level to avoid aging of the solid dielectric material.

Electrical stress limits - on the cast epoxy support insulator component are not a critical constraint of the design, as the dimensions of the GIS are mainly set by the lightning impulse withstand level of the gas gap, and the need for the conductor to have a somewhat large diameter, in order to carry load currents of several thousand amps. The result is enough space between the conductor and enclosure to accommodate support insulators having low electrical stress.

Metal used in GIS Enclosures

Enclosures are normally cast or welded aluminum, although steel is also commonly used. Steel enclosures require painting on the interior and exterior to prevent rusting.

Aluminum enclosures don't require painting, but may be painted to improve cleaning, provide a better appearance, or to optimize heat transfer to the ambient atmosphere.

Deciding between aluminum and steel is based on the cost differences between the two metals and also on the continuous current. With continuous currents exceeding roughly 2000 amps, steel enclosures will require non-magnetic inserts of stainless steel. Otherwise the enclosure material should be changed to all stainless steel or aluminum.

Grounding Individual Enclosures

The individual metal enclosure sections of the GIS modules are electrically connected.

This is accomplished through either of two means:

- 1.) The flange's enclosure joint being a good electrical contact in itself.
- 2.) With external shunts bolted to the flanges or to grounding pads on the enclosure.

Grounding of Single and Three Phase Enclosures

Earlier single-phase GIS enclosures - were single-point grounded to prevent circulating currents from flowing in the enclosures. Presently, the practice is to use “multi-point grounding” even though this leads to some electrical losses in the enclosures due to circulating currents.

Three enclosures of a single-phase GIS - should be bonded together at the ends of the GIS to encourage circulating currents to flow. These circulating enclosure currents act to cancel the magnetic field that would otherwise exist outside the enclosure due to the conductor current.

Three-phase GIS enclosures - do not have circulating currents, but do have eddy currents in the enclosure, and should also be multi-point grounded. With multipoint grounding and the many resulting parallel paths for the current from an internal fault to flow to the substation ground grid, it is easy to keep the touch and step voltages for a GIS to the safe levels prescribed in IEEE 80.



Pressure Vessel Specifications

Specifications for pressurized vessels in GIS enclosures are established within GIS standards. The actual design, manufacture, and testing procedures follow the established pressure vessel standard for the country where the equipment is manufactured.

Due to the modest pressures involved in GIS enclosures, and the classifying of GIS as electrical equipment, third party inspections and code stamping of the GIS enclosures are not mandatory requirements.



Rupture Discs

Rupture discs are commonly used as a safety measure in pressure vessels, although the pressure rises caused by internal fault arcs within a GIS compartment (of the usual size) is predictable and gradual enough, that the protective system will interrupt the fault before a dangerous pressure is reached.

Periodic Inspections of Internal Components not required

There is typically no need for periodic inspections or maintenance of GIS internal components.

Dry Inert Gas Environment - The interior of the enclosure is dry, with an inert gas environment that is not subject to aging.

UV Exposure - Additionally, there is no exposure of any of the internal materials to sunlight and the damaging effects of UV radiation.

Module seal deterioration - The O-ring seals in the modules are normally found to be in exceptional condition, because there is usually a double-seal system, with the outer seal protecting the inner seal.



Protection of Outdoor Enclosures

GIS equipment will not show the effects of aging, whether installed indoors or out. For outdoor GIS systems, special measures must be taken to ensure adequate protection from corrosion, effects of low and high ambient temperatures, and solar UV radiation.

Pre-assembled GIS Modules

GIS modules are typically transported in the largest, most practical assembly size possible for transport, clearance and maneuvering.

The lower voltage units can usually be delivered with two or more circuit breaker positions fully assembled.

GIS modules are connected to one another, using bolted flanged enclosure joints and conductor contacts. This makes the assembly process proceed fairly quickly.

Conductors in a GIS System

Conductors used in GIS systems

High Voltage conductors used in GIS systems are mostly aluminum, although copper is occasionally used for high continuous current ratings.

It is common to silver-plate the surfaces that transmit the current. Bolted joints and sliding electrical contacts are used in the joining together of conductor sections.

Electrical Contacts in GIS systems

There are a variety of designs for the sliding contact element. Generally, the sliding contacts have many individually sprung silver-plated, copper contact fingers working in parallel.

Contact lubricants are used to ensure that the sliding contact surfaces do not generate particles or wear out over time.

Use of Sliding Conductor Contacts to improve Module Assembly

Sliding conductor contacts make the assembly of the modules much easier, while also allowing for conductor movement to accommodate differential thermal expansion of the conductor in relation to the enclosure.

These sliding contact assemblies are also used with circuit breaker and switch equipment for transferring current from the moving contacts to the stationary contacts.

Circuit Breaker and Transformers used in GIS Systems

Circuit Breakers

Both AIS and GIS use basically the same type of dead tank SF6 puffer circuit breaker.

However, with GIS systems, Instead of SF6-to-air bushings mounted on the circuit breaker enclosure, the GIS circuit breaker is directly connected to the adjacent GIS module.



Current Transformers for GIS Applications

Current transformers are devices which are installed in substations for the purpose of transforming the high current from the conductor into standardized, equivalent values, which are then used for purposes of metering, measuring and protection.

Installation Location - Current transformers installed in a GIS system are of the inductive-ring type, and can be installed either inside or outside the GIS enclosure.

Metering and protection - are performed on the secondary winding side of the transformer.

The GIS conductor is the single turn primary for the current transformer unit.



Considerations for Current Transformers

For CTs installed on the inside of the enclosure - they must be shielded from the electric field produced by the high-voltage conductor, otherwise high transient voltages can appear on the secondary winding through capacitive coupling .

For CTs mounted on the outside of the enclosure - the enclosure itself must have an insulating joint, and enclosure currents shunted around the CT.

Both of these types of GIS construction are widely use.

Digital Output Signals from CTs - Analog Relays

Advanced types of CTs have been developed to save space and reduce the cost of GIS, by removing the magnetic core or Rowgowski coil.

The output signals of these types of CT units are at a low level, allowing for the immediate conversion by an enclosure-mounted device, into a digital signal.

Once the signal is digital, It can be transmitted over long distances via wire or fiber optic cabling, to the control or protective relays.

One issue though is, many protective relays being used by utilities do not presently accept a digital input even though the relay may be converting the conventional analog signal to digital, prior to processing.

Voltage Transformers

Voltage transformers (VTs) used in GIS applications are the inductive type with an iron core. The VT is usually a sealed unit with a gas barrier insulator.

Installation Option 1 - the VT is easily removable so the GIS can be high voltage tested without damaging the unit.

Installation Option 2 - the VT is provided with a disconnect switch or removable conductor link.

Primary winding - is supported on an insulating plastic film immersed in SF₆.

To prevent capacitive coupling of transient voltages - the VT should possess an electric field shield between the primary and secondary windings.



Voltage Sensors

Advanced voltage sensors have been developed which use a simple capacitive coupling cylinder between the conductor and enclosure.

Advantages – have a reduced size and cost. Also these capacitive sensors do not require disconnection for the routing high-voltage withstand test.

The output signal level from the voltage sensor is low, so it can be immediately converted to a digital signal. This signal encounters the same barrier (with protective relaying limitations) as the advanced CT output signal, mentioned previously.

Switching and Arrester Devices used in GIS Systems

Disconnect Switches

Components of a disconnect switch - includes a moving contact that opens or closes a gap between stationary contacts, when activated by an insulating operating rod, that is moved by a sealed shaft which runs through the enclosure wall.

Stationary contacts – these have shields that provide the appropriate electric field distribution to avoid too high a surface electrical stress.

Contact operating velocity - the velocity of the moving contacts in a disconnect switch is relatively low in comparison to that of a circuit breaker's moving contacts. The disconnect switch is only able to interrupt low levels of capacitive or small inductive currents.

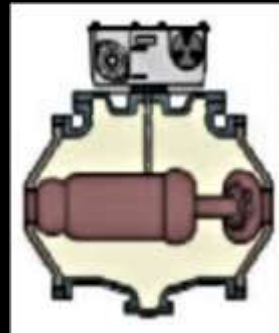

Fast-acting Disconnect

For transformer magnetizing current interruption duty, the disconnect switch is provided with a fast acting spring operating mechanism.

Load break disconnect switches – This type of disconnect switch has been used in the past in GIS systems. However, with improvements and cost reductions of circuit breakers, it is no longer practical to continue installing this type, as a circuit breaker should be used instead.

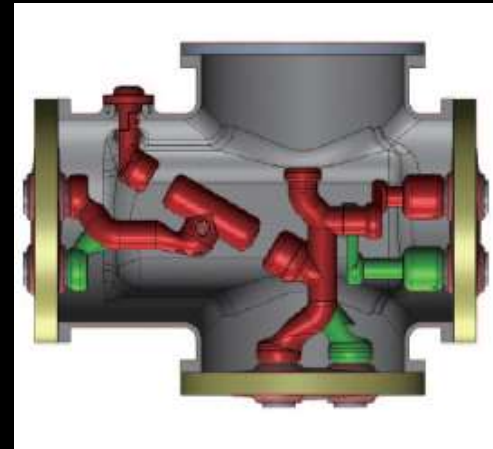

Combination Disconnect-Earthing Switch

Design of the combined disconnector/earthing switch allows for a reduction in space. There are 3 positions: disconnector closed/earthing switch open; disconnector open/earthing switch open; and disconnector open/earthing switch closed.

A motor operated actuator drives the combined disconnector/earthing switch, with interlocking between the disconnector and earthing switch to allow for safe operation.

When used as busbar disconnecting switch, the unit can be connected to the busbar with a compensator to eliminate the mechanical stress due to tolerances and thermal expansion.

Fast disconnect can be chosen when functioned as feeder disconnecting to break the bus-transfer current.

Ground Switches

Ground switches have a moving contact that opens or closes a gap between the high-voltage conductor and the enclosure.

Sliding contacts – these electric-field shielded contacts are incorporated at the enclosure and the conductor.

Maintenance ground switch – This type is operated either manually or by motor drive to close or open in several seconds.

Fully closed - it can carry the rated short-circuit current for the specified time period (1 or 3 sec) without damage.

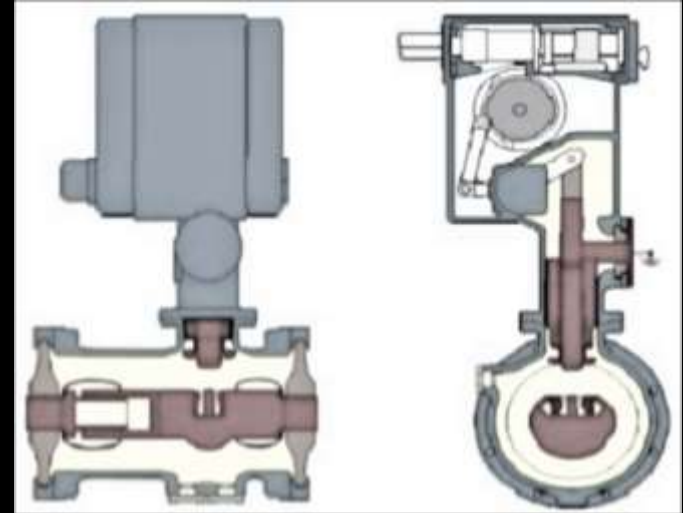

Fast-acting Type of Ground Switch

A fast-acting type of ground switch has a high speed drive, which is typically a spring mechanism, and contact materials that withstand arcing.

It can be closed twice onto an energized conductor without causing significant damage to itself or adjacent parts.

Installation location - Fast-acting ground switches are often installed at the connection point of the GIS to the remainder of the electric power network.

It is located here in case the connected line is energized, and also so that the fast acting ground switch is better able to handle discharge of a trapped charge.

Testing with the use of Shunt

Ground switches are normally provided with an insulating mount or an insulating bushing for the ground connection.

During normal operations - the insulating element is bypassed with a bolted shunt to the GIS enclosure.

During installation or maintenance - with the ground switch closed, the shunt can be removed, then the ground switch used as a connection between the test equipment and the GIS conductor.

Voltage and current testing of the internal parts - of the GIS can then be done without removing SF6 gas or opening the enclosure. A typical test would involve the measurement of contact resistance using two ground switches.

Surge Arresters

Cable and direct transformer connections within a GIS system are not susceptible to lightning strikes.

Because GIS conductors are housed inside a grounded metal enclosure, the only pathway for lightning impulse voltages to enter and cause damage is through the connection of the GIS to the remainder of the electrical system.

Therefore, protection at the SF₆-to-air bushing connections and at transformers are the main areas of concern.

The zinc oxide type of surge arrester element is well-suited for immersion in an SF₆ environment.

These are supported by an insulating cylinder inside the GIS enclosure section.



Air Insulated Surge Arresters vs Gas Insulated

Air-insulated surge arresters in parallel with the SF6-to-air bushings usually provide adequate protection of the GIS from lightning impulse voltages at a much lower cost than SF6 insulated arresters.

With the AIS - there is a significant decrease in withstand voltage for switching surges compared to lightning impulse because the longer time-span of the switching surge allows time for the discharge to completely bridge the long insulating distances in air.

With the GIS - the short insulation distances can be bridged in the short time-span of a lightning impulse; so the longer time-span of a switching surge does not significantly decrease the breakdown voltage.

Insulation coordination studies usually show there is no need for surge arresters in a GIS; however, many users specify surge arresters at transformers and cable connections as the most conservative approach.

Connections in a GIS Systems



Interconnecting Buswork

When connecting GIS modules which are not directly connected, an SF6 bus that consists of an inner conductor and outer enclosure is used.

Ancillary components such as support insulators, sliding electrical contacts and flanged enclosure joints are usually the same as those used for the GIS modules.

The length of a section of bus is normally limited to about 6 meters, (by the allowable span between the conductor contacts and support insulators.)

(GIL) gas-insulated transmission lines - There are specialized bus designs which have section lengths of 20 meters that have been developed, and are applied to both GIS and separate transmission link applications.



SF6 to Air Bushings

SF6-to-air bushings consist of a hollow insulating cylinder which is attached to a flange on the end of a GIS enclosure.

This insulating cylinder contains pressurized SF6 gas on the smooth surfaced interior, and can be exposed to atmospheric air on the outside.

Conductor - The conductor continues up through the center of the insulating cylinder to a metal end plate. The outside of the metal end plate allows for the bolting of an air insulated conductor.

Gas pressure inside bushings - The SF6 gas inside the bushing is usually the same pressure as the rest of the GIS system.

SF6 to Air Bushings (continued)

Moisture and contaminant shields or sheds – located on the outside of the bushing, these improve the performance of the bushing in wet or contaminated conditions.

Internal metal shields – these help to control electric-field distribution.

External Shields - higher voltage SF6-to-air bushings also use external shields.

Material of insulating cylinder – in the past these were often made of porcelain, but many now are made of a composite consisting of fiberglass epoxy inner cylinder with an external weather shed of silicone rubber.

The composite bushing has better contamination resistance and is normally safer than porcelain as it will not fracture.



Power Cable Connections - Cable Termination Kit

The power cabling connections for a GIS system are fitted with a cable termination kit, to provide a physical barrier between the cable dielectric and the SF6 gas in the GIS.

The cable termination kit provides a suitable electric-field distribution at the end of the cable, and because the cable termination will be in SF6 gas, the length is short and sheds are not required.

Cable conductor connections - are the bolted or compression type, and attach to the end plate or cylinder of the cable termination kit.

Power Cable Connections – Testing Port

On the gas side, there is a removable link or plug in contact. This contact transfers current from the cable to the GIS conductor.

Testing - For the high-voltage testing of the GIS or the cable, the cable is disconnected from the GIS by removing the conductor link or plug in contact.

Testing Access Port – on the GIS enclosure nearby to the cable termination, there is usually an access port. This port can also be used for attaching a test bushing.



Plug-in Type of Cable Termination Kit

There are plug-in termination kits available for solid dielectric power cables up to a system voltage of 170 kV.

This type of connection allows for one section of the plug-in termination to be installed during the manufacturing process, so that the GIS cable termination compartment can be factory sealed and tested prior to delivery.

Once in the field, the power cable with the mating terminator section can be installed on the cable, and plugged into the factory installed termination part on the GIS.

Power cables are stiff, and difficult to bend, or may be direct-bury. In these cases a disconnect link is still needed in the GIS termination closure.

SF6 to Oil Connections

For connecting a GIS conductor directly to a transformer, a special SF6-to-oil bushing that mounts on the transformer is needed.

Transformer side - The bushing connection is immersed in oil on the end with the transformer's high-voltage leads.

SF6 gas side - has a removable link or sliding contact for connection to the GIS conductor. The bushing may be an oil-paper condenser type or solid insulation type.

Because leakage of SF6 into the transformer oil must not occur, most bushings have a center section, allowing SF6 leaks to disperse into the atmosphere rather than the transformer.

For testing - the SF6 end of the bushing is disconnected from the GIS conductor after gaining access through an opening in the enclosure.

The enclosure of the transformer can also be used for attaching a test bushing .

The Control System of a GIS

Local Control Cabinet

In wiring the GIS back to the substation control room, a local control cabinet (LCC) is usually provided for each circuit breaker position.

Shielded multi-conductor control cables - are used for the control/power wires (for operating mechanisms, alarms, heaters, auxiliary switches, CTs, and VTs) which are run between the GIS equipment modules and the LCC.



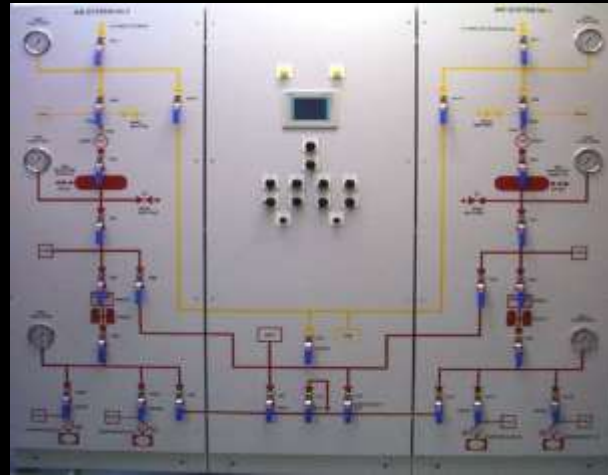

Inside the LCC unit

Mimic diagram – Along with terminals for all GIS wiring, the LCC includes a mimic diagram of the part of the GIS being controlled.

Switches/Indicators – incorporated into the mimic diagram are control switches and position indicators for the circuit breaker and switches.

Annunciation of alarms, electrical interlocking and other control functions - are also usually provided in the LCC.

The LCC is not an essential component of the GIS. Even so, it is a well established and popular feature which is a part of most GIS systems.

Very Fast Transient Voltages

Switching and circuit breaker operations in a GIS produce surge voltages internally, with a very fast rise time in the nanosecond range, with peak voltage levels of around 2 per unit.

These very fast transient voltages do not cause a problem inside the GIS, as the duration of this type of surge voltage is very short, (being much shorter than the lightning impulse voltage.)

Though an issue which can arise is, a portion of the very fast transient voltages can emerge from the inside of the GIS at any location where a discontinuity of the metal enclosure occurs; (In locations such as insulating enclosure joints for external CTs or at the SF6-to-air bushings.)

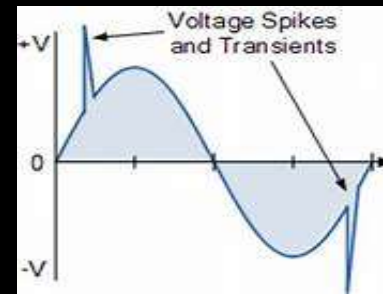

Transient Voltages in Control Wiring

Transient ground rise voltage on the outside of the enclosure may cause minor sparking across the insulating enclosure joint or sparking with adjacent grounded parts.

While the appearance of this may be alarming, it is not harmful as the shock potential is very low. However, if these very fast transient voltages enter the control wires, they can cause operational errors in the control devices, with solid-state controls being particularly affected.

Shielding and grounding – proper shielding and grounding of the control wires can remedy this situation.

In a GIS the control cable shield should be grounded at both the equipment and the LCC ends using either coaxial ground bushings or short connections to the cabinet walls at the location where the control cable first enters the cabinet.

Gas Monitoring and Leak Detection System

Gas Monitor System

Insulation and interruption characteristics of the SF6 gas, will depend upon the density of the gas, at a minimum level of density (which has been established by design tests.)

Pressure of SF6 gas varies with temperature, so a mechanical or electronic temperature compensated pressure switch is used to monitor the equivalent of gas density.

Allowable loss in gas density – GIS enclosures are filled with SF6 to a density well enough above the density minimum for full dielectric and interrupting capability, that 5 to 20% of the SF6 gas can actually leak out before the performance of the GIS degrades.

Density and Pressure Alarms

Density alarms provide a warning when gas leakage drops the density in the enclosure to minimum acceptable levels.

These alarms can be used to trigger the circuit breakers and switches, putting a GIS system which is losing gas, into a pre-established safety state or condition.

Using Pressure instead of Density as a trigger - because it is far easier to measure the pressure in the enclosure rather than the density, a gas monitor system may be set to measure the internal pressure of the system.

With certain pressure gauges the rate of gas leakage can also be measured.

This type of gauge is considerably more expensive than the mechanical temperature compensated pressure switches.

Gas Compartments and Zones

GIS systems are divided into separate compartments for the purpose of handling the gas, by the use of gas barrier insulators.

Because of the arcing that takes place in a circuit breaker compartment, it typically has a gas compartment to itself.

Gas handling systems - are available to easily process and store around 1000 kg of SF₆ at a time. However, this process is usually impractical, due to the length of time needed.

Therefore larger compartments are subdivided into smaller gas compartments consisting of several hundred kg per section.

Use of bypass piping to interconnect sub-compartments - These small compartments may be inter-connected with external bypass piping to create a larger gas zone for density monitoring.

Connecting Multiple Gas Compartments

Pros – While it is easier to locate the source of a leak, when the alarms correspond with small gas zones, a larger gas zone will, for the same size leak, give more time to add SF6 into the system between the first alarm and second alarm.

Cons - There are also reasons for not connecting together multiple gas compartments into large gas zones.

One reason being, a concern with a fault in one gas compartment can cause contamination in adjacent compartments, as well as a greater amount of SF6 which can be lost before a gas-loss alarm triggers.

Testing and Installation

Testing Requirements

Test requirements - for circuit breakers, CTs, VTs, and surge arresters are not specific for GIS.

Representative GIS assemblies - having all of the parts of the GIS (with the exception of the circuit breaker) are design tested to show the GIS can withstand the rated lightning impulse voltage, switching impulse voltage, power frequency overvoltage, continuous current, and short-circuit current.

Test standards - these specify the test levels and how the tests must be performed.

Production tests of the factory assembled GIS (including the circuit breaker) cover power frequency withstand voltage, conductor circuit resistance, leak checks, operational checks, and CT polarity checks.

Other components - such as support insulators, VTs, and CTs are tested in accordance with specific requirements before assembling into the GIS.

Field tests repeat the factory tests.

Power Frequency Withstand Voltage Test

Power frequency withstand voltage test - is the most important means to evaluate the cleanliness of the inside of the GIS in regard to contaminating conducting particles.

Checking of interlocks - is also a very important testing procedure.

Other field tests - may be required, such as a surge voltage test, if the GIS is a critical part of an electric power grid.



Air Evacuation and Gas Filling

Evacuation of air from gas compartments that have been opened is required once the system is sealed, filling with SF₆ gas and control system wiring. Appropriate field tests are then completed.

When the high-voltage GIS units are shipped as multiple, separate modules, the installation and testing of these units will take around two weeks per circuit breaker position.

Lower voltage systems which were shipped as complete bays, and factory wired, can be installed considerably faster.

Operational Procedures for a GIS

Operational Procedures

The operational procedures of a GIS such as providing systems monitoring, control, and protection of the power is the similar to that of an AIS, except that internal faults are not self-clearing, so reclosing should not be used for faults internal to the GIS.

Disconnect and Ground Switch Operations

Special care and attention should be given to disconnect and ground switch operations.

If these units are opened with the load current flowing, or closed into load or fault current, the arcing between the switch moving and stationary contacts will usually cause a:

- Phase to phase fault in three-phase enclosure GIS
- Phase to ground fault in single-phase enclosure GIS

These internal faults will cause severe damage inside the GIS, and a GIS switch is not easily or quickly replaced as with an AIS switch.

Pressure rise due to Internal Faults

During a fault condition, the internal pressure will rise in the GIS gas compartment as an arc heats the gas.

In extreme cases - the internal arc will cause a rupture disk to operate or may even cause a burn-through of the enclosure. If this occurs, the resulting release of hot decomposed SF₆ gas may cause serious burn injuries to nearby personnel.

Safety Interlocks - To properly protect the GIS system and GIS personnel, secure interlocks are provided so that the circuit breaker must be open before an associated disconnect switch can be opened or closed, and the disconnect switch must be open before the associated ground switch can be closed or opened.

Operational Wear on Internal Parts

Over the years as GIS has been put into full service, experience has shown that the internal parts of the GIS are so well protected inside the metal enclosure that they do not age.

As a result of proper material selection and lubrication, there is a negligible amount of wear on the switch contacts.

Contacts and Nozzles - Only the arcing contacts of the circuit breaker and the Teflon nozzle of the interrupter show a degree of wear which is proportional to the number of operations and the level of the load or fault currents being interrupted.

The materials used in the manufacturing of contacts and nozzle parts, combined with the short interrupting period of modern circuit breaker equipment, provide typically for thousands of load current interruption operations and tens of full rated fault current interruptions before there is a need for inspection and/or replacement.

Inspections

Inspecting Circuit Breakers - With the exception of circuit breaker equipment, for special use applications such as a pumped storage plant, most circuit breakers will seldom require an internal inspection. Likewise, most GIS will never require opening for maintenance.

Checked and Repaired – When circuit breakers are subjected to repeated tripping, they should be checked and repaired after 6,000 times of mechanical operation, while an interrupter should be overhauled after breaking 20 times of rated short-circuit current up to 40kA.

Operational experience suggests that this maintenance regiment far surpasses the performance requirements.

Replacing faulty GIS systems

Faulty Designs - The replacing of earlier installations of GIS has been necessary in some isolated cases because of inherent failures in the design, or due to persistent corrosion and sealing failures that would cause SF6 leakage issues.

Most of these earlier designs are no longer in use or being built, and in some cases the manufacturer is no longer in business.

Replacement process – When space allows, a new GIS (or AIS) may be built adjacent to the GIS being replaced, with connections to the power system transferred to the new system.

When no space is available, the GIS can be replaced one section at a time using custom designed temporary interface bus sections between the old and new systems.

Bibliography:

1. Siemens Energy Sector , Power Engineering Guide (7th Edition), 2014
2. IEEE Guide for Gas-Insulated Substations, IEEE Std. C37.122.1, 1993
3. IEEE Standard for Gas-Insulated Substations, IEEE Std. C37.122, 1993
4. IEEE Guide to Specifications for Gas-Insulated, Electric Power Substation Equipment, IEEE Std. C37.123, 1996
5. IEEE Guide for Moisture Measurement and Control in SF6 Gas-Insulated Equipment, IEEE Std. 1125, 1993
6. John McDonald, Electric Power Substations Engineering, 3rd ed., CRC Press, 2012
7. IEC 62271-203: Gas-insulated metal-enclosed switchgear for rated voltages of 72.5 kV and above, 1990
8. IEC 1634: IEC: use and handling of Sulphur Hexafluoride (SF6) in HV switchgear and control gear, 1995
9. Wikipedia: “Gas-Insulated Switchgear”, “Electric Substation”, “Hybrid Switchgear Module”, “Sulfur Hexafluoride Circuit Breaker”
10. ABB, “ABB Switchgear Manual”, 10th Ed., 2001 (English translation version)
11. ABB, “Gas Insulated Switchgear ELK-04 Product Brochure”, 2009

This concludes our course on “An Overview of Gas Insulated Substations”.
You may now proceed to the final exam.

Thank you for taking this Flashcard course!

An Overview of Gas-Insulated Substations, 2019 Edition

First Printing: February, 2019

Copyright © 2019 by Don Parnell, PE

All rights reserved. No part of this courseware may be reproduced or distributed, or transmitted in any form or by any means, including, without limitation, electronic, optical, or mechanical means (by way of example and not limitation, photocopying, or recording by or in an information storage retrieval system) without express written permission of the above mentioned courseware developers.